

**Nakamichi DRAGON**

Auto Reverse Cassette Deck

Owner's Manual

Congratulations!

You have chosen a truly unique cassette deck. The Nakamichi DRAGON is a direct-drive, auto-reverse cassette deck incorporating the epoch-making "NAAC" system for automatic azimuth correction of the playback head.

Thanks to the NAAC system, sound quality differences between forward and reverse are completely eliminated, and perfect playback is possible under all conditions. Furthermore, manual calibration facilities for record sensitivity and bias permit high-precision adjustment to suit the requirements of every tape.

Please take the time to read this manual in its entirety to fully acquaint yourself with the various features of this cassette deck.

Thank you.

Nakamichi Corporation.

## CONTENTS

Safety Instructions.....	2
On Cassette Tapes .....	3
Precautions.....	3
Controls and Features .....	4
Connections .....	6
Special Features.....	6
Playback.....	8
Before Recording .....	9
Recording.....	12
Tips on Setting Record Levels .....	13
Dolby Noise Reduction System .....	13
Maintenance.....	14
Troubleshooting.....	15
Specifications.....	16



**CAUTION**  
RISK OF ELECTRIC  
SHOCK. DO NOT OPEN!





The lightning flash with arrowhead symbol, within an equilateral triangle, is intended to alert the user of the presence of uninsulated "dangerous voltage" within the product's enclosure; that may be of sufficient magnitude to constitute a risk of electric shock to persons.



The exclamation point within an equilateral triangle is intended to alert the user of the presence of important operating and maintenance (servicing) instructions, in the literature accompanying the appliance.

**CAUTION**

TO REDUCE THE RISK OF ELECTRIC SHOCK, DO NOT REMOVE COVER (OR BACK). NO USER-SERVICEABLE PARTS INSIDE. REFER SERVICING TO QUALIFIED SERVICE PERSONNEL.

## WARNING

TO PREVENT FIRE OR SHOCK HAZARD, DO NOT EXPOSE THIS APPLIANCE TO RAIN OR MOISTURE.

Please record the Model Designation and Serial Number in the space provided below and retain these numbers.

Model Designation and Serial Number are located on the rear panel of the unit.

Model Designation: Nakamichi DRAGON

Serial Number: \_\_\_\_\_

## Safety Instructions

The following safety instructions have been included in compliance with safety standard regulations. Please read them carefully.

1. Read Instructions — All the safety and operating instructions should be read before the appliance is operated.
2. Retain instructions — The safety and operating instructions should be retained for future reference.
3. Heed Warnings — All warnings on the appliance and in the operating instructions should be adhered.
4. Follow Instructions — All operating and use instructions should be followed.
5. Water and Moisture — The appliance should not be used near water — for example, near a bathtub, washbowl, kitchen sink, laundry tub, in a wet basement, or near a swimming pool, etc.
6. Carts and Stands — The appliance should be used only with a cart or stand that is recommended by the manufacturer.
7. Wall or Ceiling Mounting — The appliance should be mounted to a wall or ceiling only as recommended by the manufacturer.
8. Ventilation — The appliance should be situated so that its location or position does not interfere with its proper ventilation. For example, the appliance should not be situated on a bed, sofa, rug or similar surface that may block the ventilation openings; or placed in a built-in installation, such as a bookcase or cabinet that may impede the flow of air through the ventilation openings.
9. Heat — The appliance should be situated away from heat sources such as radiators, heat registers, stoves, or other appliances (including amplifiers) which produce heat.
10. Power Sources — The appliance should be connected to a power supply only of the type described in the operating instructions or as marked on the appliance.
11. Grounding or Polarization — Precautions should be taken so that the grounding or polarization means of an appliance is not defeated.
12. Power-Cord Protection — Power-supply cords should be routed so that they are not likely to be walked on or pinched by items placed upon or against them, paying particular attention to cords at plugs, convenience receptacles, and the point where they exit from the appliance.
13. Cleaning — The appliance should be cleaned only as recommended by the manufacturer.
14. Nonuse Periods — The power cord of the appliance should be unplugged from the outlet when left unused for a long period of time.
15. Object and Liquid Entry — Care should be taken so that objects do not fall and liquids are not spilled into the enclosure through openings.
16. Damage Requiring Service — The appliance should be serviced by qualified service personnel when:
  - A. The power-supply cord or the plug has been damaged; or,
  - B. Objects have fallen, or liquid has been spilled into the appliance; or,
  - C. The appliance has been exposed to rain; or,
  - D. The appliance does not appear to operate normally or exhibits a marked change in performance; or,
  - E. The appliance has been dropped, or the enclosure damaged.
17. Servicing — The user should not attempt to service the appliance beyond that described in the operating instruction. All other servicing should be referred to qualified service personnel.

# On Cassette Tapes

## Precautions

1. C-120 cassettes (playing time one hour per side) contain extremely thin tape which breaks or snarls easily, is sometimes subject to stretching and also is of low sensitivity. Therefore, C-120 cassettes are not recommended for high-fidelity recording.
2. Do not pull out the tape from the cassette housing.
3. Be careful not to turn the cassette tape reels with the fingers, causing tape slackening.
4. Store cassette tapes away from heat, high humidity, dust and magnetic fields such as caused by speakers, TV sets etc.

## Cassette Tabs

You can protect valuable recordings from accidental erasure and re-recording by completely removing the appropriate tab on the top edge of the cassette. The tab for each side is located on the top left-hand corner as you face the side. Use a small screwdriver, and push the tab down to break it off. Do not leave the broken tab in the recess. If you wish at a later date to record over a side for which the tab has been removed, cover the tab opening with a piece of adhesive tape.

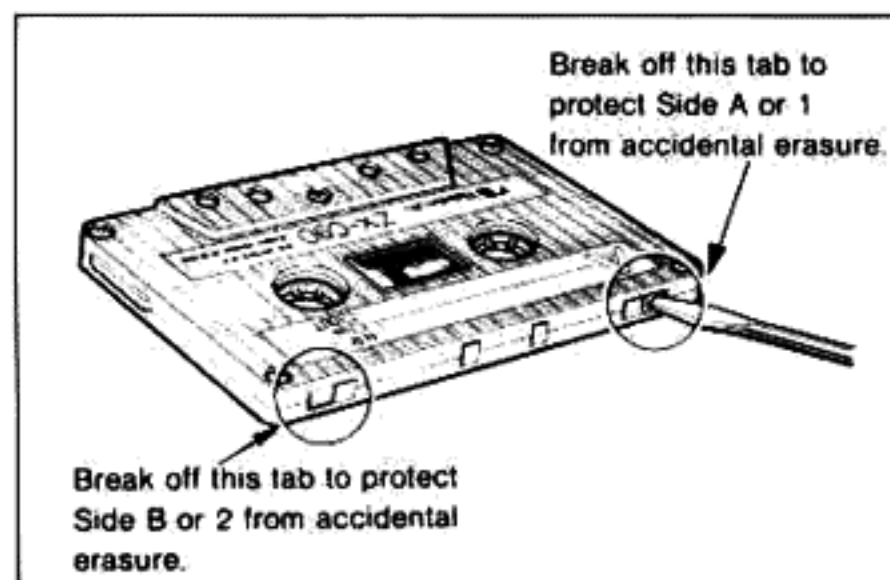

## Insertion and Removal

### (1) Insertion of a Cassette

1. Push the eject button to open the cassette holder.
2. Load the cassette into the holder from the top. Make sure that the exposed tape is facing downward.
3. Close the cassette holder gently by pushing the holder back into the panel.

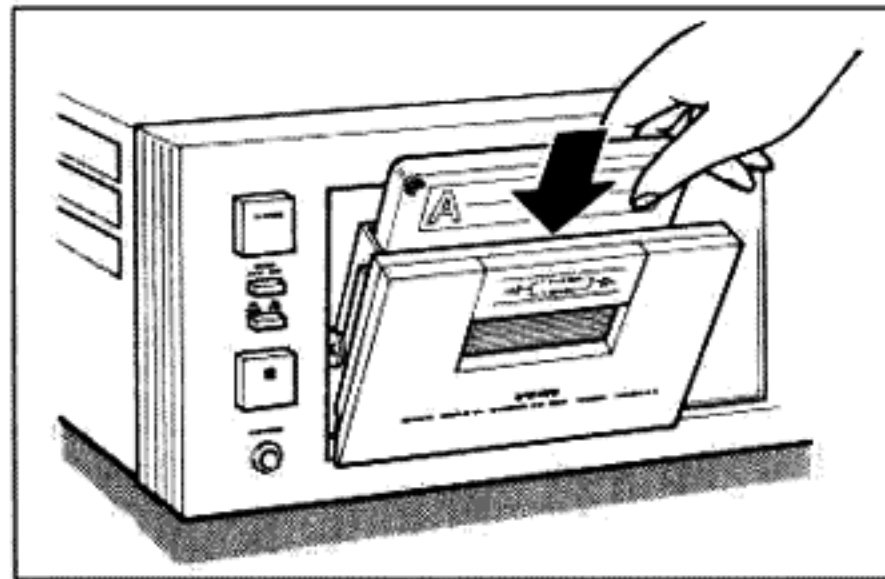

### (2) Removal of a Cassette

1. Push the stop button.
2. Push the eject button to open the cassette holder.
3. Remove the cassette.

---

## Precautions

1. Make sure that the timer switch is set to "Off" when the self-start feature is not desired.
2. This deck incorporates a special circuit designed to take up any loose tape inside the cassette. When a cassette tape is inserted, the right-hand spindle will make a few rotations. The right-hand spindle will also rotate and the tape counter will advance by a few digits if the cassette holder is closed without a cassette or the power to the deck is switched on. This behavior is normal and not a fault with the deck.
3. This deck incorporates a muting circuit to prevent the generation of transient noise when switching on the power. While the muting circuit is active, the stop button indicator flashes and the tape transport buttons are inoperative. When the timer function for recording or playback is used, the respective mode is entered after the muting interval (when the stop button indicator has stopped flashing).



# Controls and Features

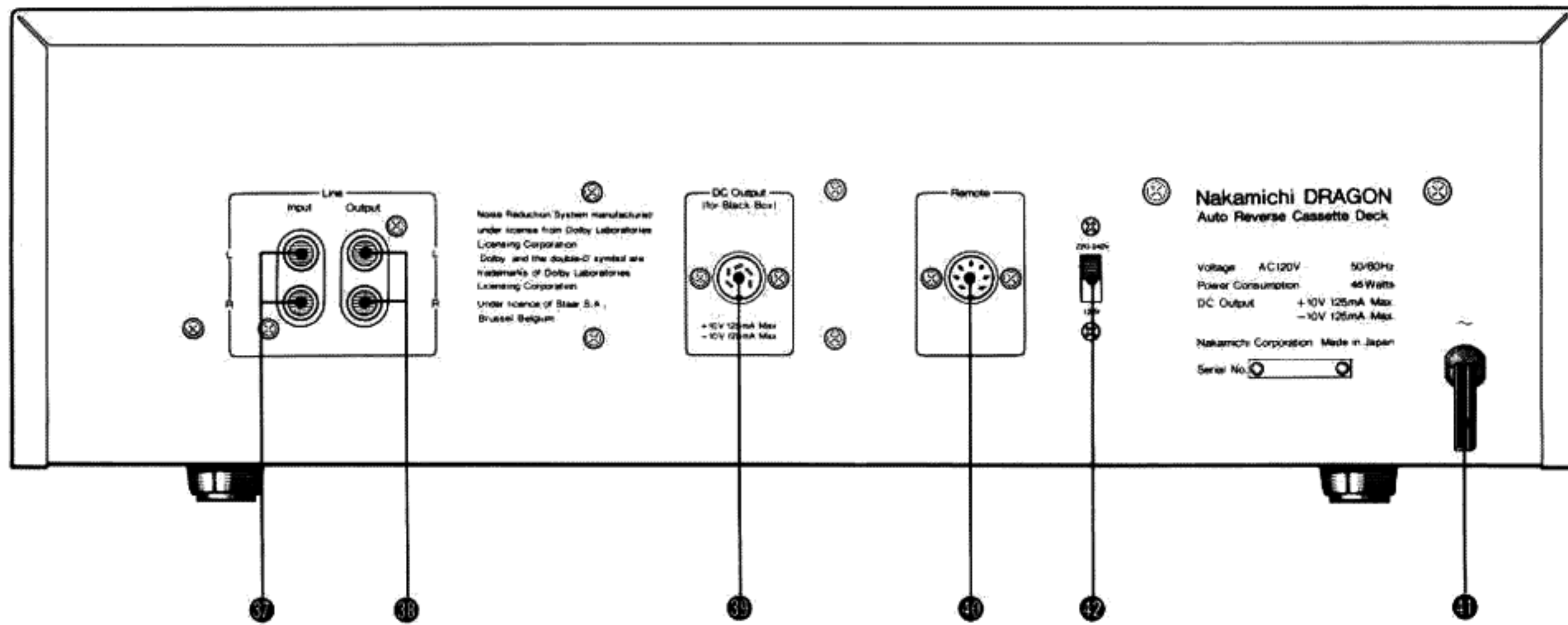
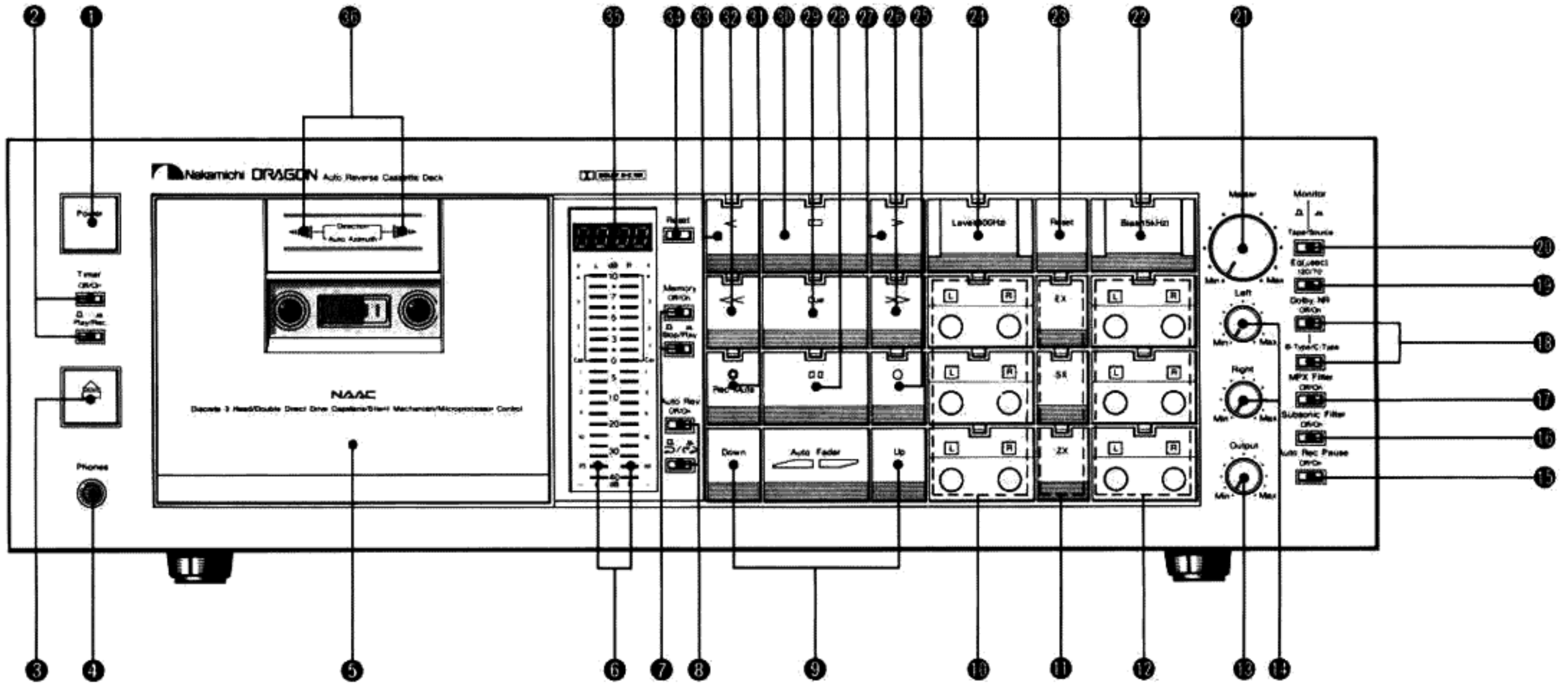

## (1) Power Switch

Pressing this button activates the deck. Pressing it once more switches the power off. When the power is switched on, the stop button indicator etc. light up to indicate readiness for operation.

## (2) Timer Switches

In conjunction with an ordinary audio timer, timer recording or timer playback is possible. When the self-start feature is not to be used, the on/off switch must be set to "Off".

## (3) Eject Button

Depressing this button opens the cassette holder for insertion and removal of a cassette.

## (4) Headphone Jack

Accepts a standard stereophone plug. Headphones with an impedance of 8~150 ohms should be used.

## (5) Cassette Holder

The cover can be easily removed for routine cleaning of heads, etc. (→p. 14)

## (6) Peak Level Meters

Provide exact indication of peak levels in the range of -40 dB to +10 dB.

## (7) Memory Switches

When the on/off switch is set to "On" (  ) and the stop/play switch to "Stop" (  ), the tape is stopped at the tape counter indication "0000"

during fast-forward or fast-reverse. When the stop/play switch is set to "Play" (  ), playback starts from the "0000" indication during fast-forward or fast-reverse.

## (8) Auto Reverse Switches

With the auto reverse on/off switch and the reverse mode switch  /  , the desired operation mode for playback of one or both sides of a cassette is selected.

## (9) Auto Fader

By means of these controls, fade-in or fade-out during recording can be performed easily at the touch of a button. There is also a choice between two fading speeds. (→p. 6)

**(10) Sensitivity Controls**

Used to adjust the record sensitivity (record/playback level) for each tape selector position and for left and right channels separately. (→p. 10)

**(11) Tape Selector Buttons**

Used to select the EX, SX or ZX position. For Nakamichi EX and EX II tapes and other high-density LH tapes, push the "EX" button. For Nakamichi SX and SX II tapes and other chrome-position tapes, push the "SX" button. For Nakamichi ZX and other metal tapes, push the "ZX" button. The respective indicator lights up. (→p. 12)

**(12) Bias Controls**

Used to adjust the bias current for each tape selector position and for left and right channels separately. (→p. 10)

**(13) Output Level Control**

Controls the output level and the headphones listening level.

**(14) Input Level Controls (Left, Right)**

Used to adjust the input (record) level to the deck for left and right channel, as well as the left/right channel balance. Fade-in or fade-out can be performed with the auto fader. (→p. 6)

**(15) Auto Rec Pause Switch**

When this switch is set to "On", a blank space (no-signal condition) of more than 10 seconds during recording causes the deck to automatically enter the record/pause (recording stand-by) mode.

**(16) Subsonic Filter Switch**

Used to cut off harmful low-frequency noise such as turntable rumble etc. during recording from phonograph records. (→p. 8)

**(17) MPX Filter Switch**

Used to cut off the 19-kHz multiplex carrier signal from FM broadcasts, which could otherwise interfere with correct operation of the Dolby NR system. When not recording from FM broadcasts, this switch should be set to "Off". (→p. 8)

**(18) Dolby NR Switches**

Used to activate the Dolby NR system and select either the Dolby B-Type NR for a 10-dB improvement in mid/high-frequency S/N ratio, or the Dolby C-Type NR for a 20-dB improvement.

**(19) Eq Switch**

Used to select the proper equalization for each tape in recording and playback. Refer to the list on page 12.

**(20) Monitor Switch**

For playback of a tape, for off-the-tape monitoring during recording and for any calibration, set this switch to the "Tape" position. For record level setting etc., set the switch to the "Source" position.

**(21) Master Input Level Control**

Turn up the master input level control to a certain degree and adjust the left/right channel balance with the left and right input level controls. Then use the master input level controls for the final record level setting. Fade-in or fade-out can be performed with the auto fader. (→p. 6)

**(22) Bias Calibration Button**

Used when performing bias current calibration. (→p. 10)

**(23) Calibration Reset Button**

Used to release the calibration mode after calibration of record sensitivity and bias current is completed. (→p. 10)

**(24) Level Calibration Button**

Used when performing calibration of record sensitivity (record/playback level). (→p. 10)

**(25) Record Button**

Used for recording. During recording, the indicator above the button lights up.

**(26) Fast-Forward Button**

Press the button for rapid tape winding in the forward direction. During operation, the indicator above the button lights up.

**(27) Forward Play Button**

Used to start playback in the forward direction or recording. During operation, the indicator above the button lights up.

**(28) Pause Button**

Used for short-term interruption of the tape transport in recording or playback and also to initiate the recording or playback stand-by mode. During operation, the indicator above the button lights up.

**(29) Cueing Button**

Used for tape cueing to easily find a desired spot on the tape. During operation, the indicator above the button lights up. (→p. 7)

**(30) Stop Button**

Used to completely stop the tape transport from any mode. During operation, the indicator above the button lights up.

**(31) Rec Mute Button**

By depressing this button during recording, the input signal can be temporarily cut off. During operation, the indicator above the button lights up.

**(32) Fast-Reverse Button**

For rapid tape winding in the reverse direction. During operation, the indicator above the button lights up.

**(33) Reverse Play Button**

Used to start playback in the reverse direction.

**(34) Tape Counter Reset Button**

Pressing this button returns the tape counter indication to "0000".

**(35) Tape Counter**

Indicates the relative tape position at any given time and can be used to index the tape, etc. The indicators count from "0000" to "9999" in the record, forward playback and fast-forward modes ("plus count") and to "-999" in the reverse playback and fast-reverse modes ("-minus count").

**(36) Direction Indicators**

Show the direction of normal-speed tape travel. In reverse or forward playback the left or right indicator lights up in green color, and in recording (forward direction only) the right indicator lights up in red. During automatic correction of playback head azimuth, the indicator is flashing.

**(37) Line Input Jacks (Left and Right Channel)****(38) Output Jacks (Left and Right Channel)****(39) DC Output Jack (For Nakamichi BlackBox Series Only)**

Provides a DC voltage to power optional components from Nakamichi's BlackBox series (such as the MX-100 Microphone Mixer, etc.). The maximum capacity of this outlet is 125 mA. Make sure that components connected to this jack do not exceed 125 mA in total current consumption.

**(40) Remote Control Jack**

Accepts the respective plug of the optional remote control unit to control tape operation from a distance.

**(41) Power Cord****(42) Voltage Selector**

AC voltage is factory set for the country in which you purchased your cassette deck. The voltage selector permits re-setting of mains voltage in case the deck is to be used in a different country.

**Note:** Safety regulations in certain countries prohibit inclusion of a voltage selector. This feature, therefore, may be absent from your deck.



# Connections

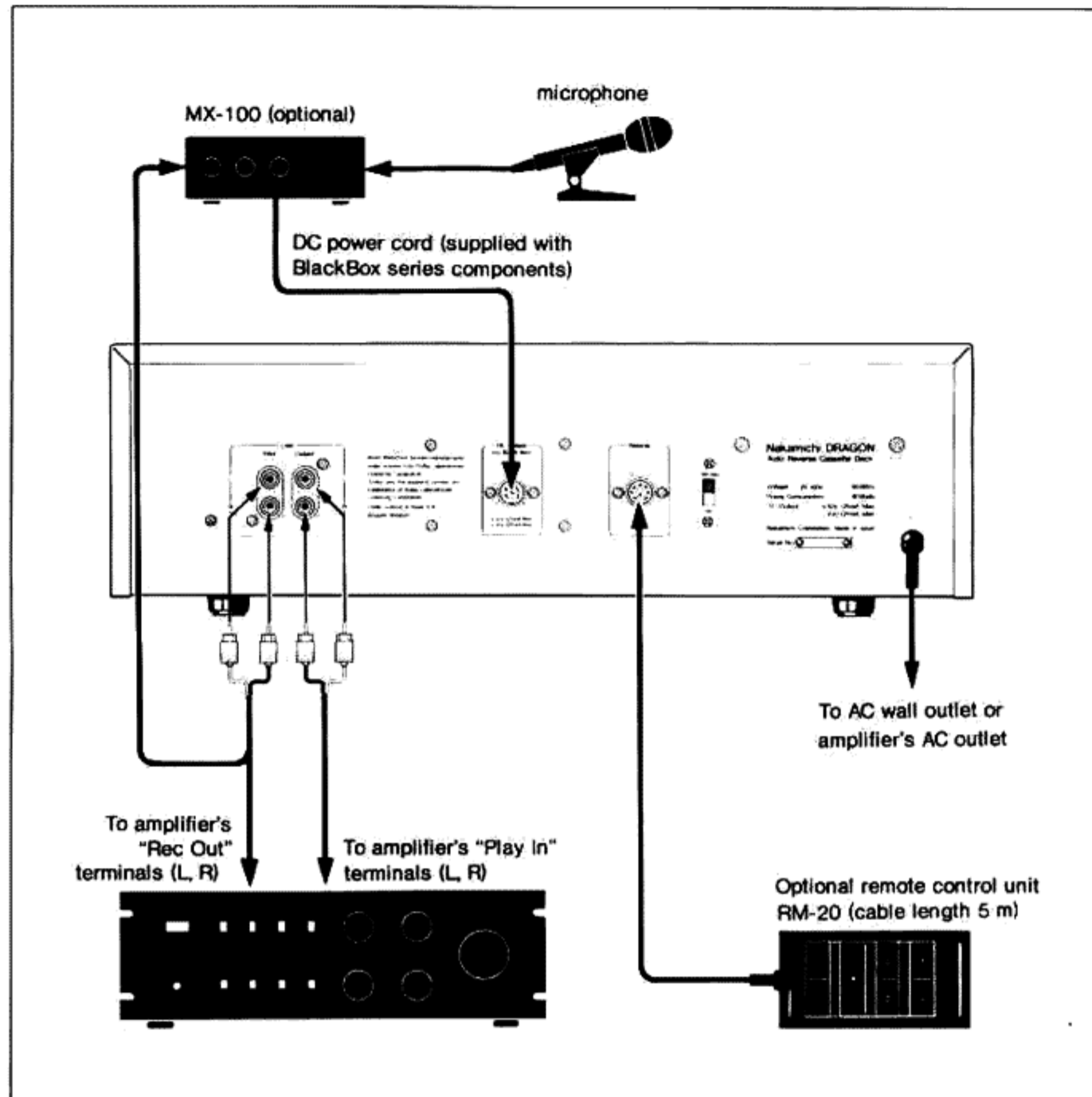

## Amplifier Connection

After checking the instructions for your amplifier or receiver, use the shielded cables with RCA plugs (provided with the deck) to make secure connections as shown in the chart. Be careful not to mix up left and right channels. While making connections, the power to the deck and to the amplifier should be switched off.

## Remote Control

The optional remote control unit RM-20 permits operation of the deck's tape transport functions from any convenient location.

## Microphones

As this deck possesses only line input facilities, direct connection of microphones is not possible. When microphones are to be used, a separate microphone amplifier, such as the optionally available MX-100 Microphone Mixer from Nakamichi's BlackBox series, is required. The MX-100 is a simple and easy-to-use microphone mixer providing three inputs (left, right and center "blend") which can be mixed freely.

As this deck provides a DC output jack on the rear panel to power components from the BlackBox series, the power supply unit (PS-100) is not required.

- The DC output jack is designed for use with components from Nakamichi's BlackBox series only. Do not connect any other units to this jack. As the maximum capacity of this outlet is 125 mA, be careful that the total rated current consumption of components connected to this jack does not exceed 125 mA. If you wish to operate multiple BlackBox components which exceed 125 mA in total current consumption, a PS-100 Power Supply unit (rated capacity 200 mA) must be used.

Power Consumption of BlackBox Components

BlackBox Component	Current Rating
MX-100 Microphone Mixer	50 mA
EC-100 Electronic Crossover	100 mA

# Special Features

## 1. Auto Fader Control

This feature permits smooth and easy fades during recording simply by pressing a button. Fade-in is performed by pressing the "Up" button, and fade-out by pressing the "Down" button. You can choose between two fading speeds: Depressing the button strongly (two clicking sounds of the switch) and keeping it depressed causes the fading process to be performed in about 2 seconds. Depressing the button lightly (one clicking sound of the switch) or releasing the button after one push causes the fading process to be performed in about 6 seconds.

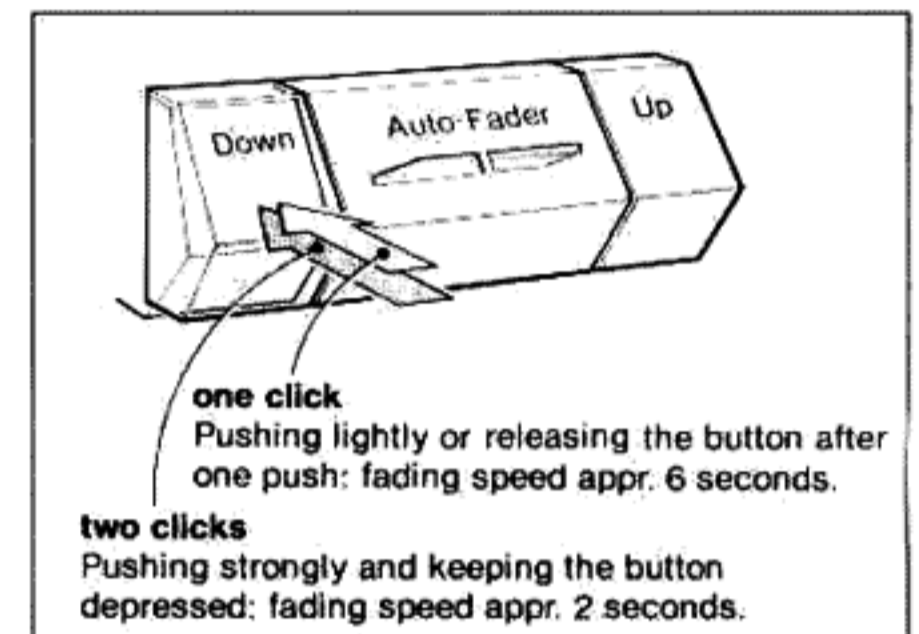

The respective fading mode is indicated by the relative brightness of the auto fader indicators. In ordinary music recording, slow-speed fading may be more desirable, while high-speed fading can be used effectively for example to eliminate noise when the cartridge is lowered onto a record, etc.

### Note:

- The operation of the auto fader can be changed from "Up" to "Down" or from "Down" to "Up", but it cannot be stopped midway.
- The auto fader is operative only in the record and record stand-by modes. In other modes, the setting is automatically "Up".

## 2. Auto Rec Pause

If the auto rec pause switch is set to "On", this feature causes the deck to automatically enter the record/pause (record stand-by) mode, thereby stopping the tape motion, when during recording a no-signal condition of more than 10 seconds is encountered.

This feature is useful for example when dubbing an LP record onto one side of a C-90 cassette. After one side of the LP is fully played, the deck automatically enters the record/pause mode. The need to constantly supervise the recording or otherwise to rewind the tape and search for the precise and location is eliminated. To re-start the recording, press the forward play button.

## 3. Rec Mute

This feature is used to temporarily cut off the input signal during recording. When the rec

mute button is depressed, the input signal is muted for as long as the button is kept depressed, and a blank portion is recorded on the tape. During this operation, the indicator above the button lights up. If the rec mute operation is performed with the auto rec pause switch set to "On", the deck automatically goes into the record/pause mode after appr. 10 seconds. However, this does not apply if the rec mute function is activated via the remote control unit RM-20.

When the monitor switch is set to "Source", the line and headphone output is not muted. This deck's rec mute indicator is set to display the condition when the recording signal current is cut off. Therefore the indicator lights up not only during rec mute operation, but also for example in the record/pause mode. When entering the record mode from the stop mode, the rec mute indicator lights up for an instant, because the muting is activated until the heads touch the tape.

#### 4. Cueing

Monitoring the high-pitched sounds from the tape while it is being fast-wound is called cueing. This can be used to locate the beginning of a musical selection, etc.

##### ■ Operation

When the cueing button is depressed in the fast-forward or fast-reverse mode (respective indicator lit), the head assembly is moved closer to the tape and winding speed is reduced to one-third, letting you hear the recorded signals from the tape. When you approach the desired spot on the tape, you can further reduce winding speed to approximately one-sixth by pressing and holding the fast-forward or fast-reverse button. If you have

moved the tape too far in one direction, you can change the direction of tape travel while remaining in the cueing mode simply by pressing the opposite fast-winding button. Pressing both fast-winding buttons simultaneously will stop the tape with the deck remaining in the cueing mode. (At this time, the pause button indicator lights up.) If you release both buttons simultaneously, the deck goes into the pause mode, and playback can be started easily from this point by pressing the desired play button. The cueing mode can be released by pressing the stop button.

- Cueing can be performed only for the direction shown by the direction indicators.

#### 5. Punch-In Recording

This feature serves to directly enter the record mode from the forward playback mode without stopping the tape. It can be used to immediately start a recording from playback or later insert another recording source on silent passages left in previous recording, etc. Also, with this deck the record/pause mode can be entered directly from the pause mode without using the stop button.

##### ■ Operation

In the forward play mode, while depressing the forward play button, press the record button. In addition to the forward play button indicator, the record button indicator lights up and recording starts without the tape motion being interrupted.

To enter the record/pause mode from the pause mode, press the record button while keeping the pause button depressed. The record button indicator flashes for about 2 seconds and then lights up continuously to indicate the record/pause mode.

#### Note:

- If the tabs on the rear of the cassette are removed, it is not possible to enter the record mode.
- For punch-in recording, always press the forward play button or the pause button before you press the record button. If the record button is pressed first, the operation cannot be performed.
- If during reverse playback the record button is pressed while keeping the reverse play button depressed, the tape motion stops.

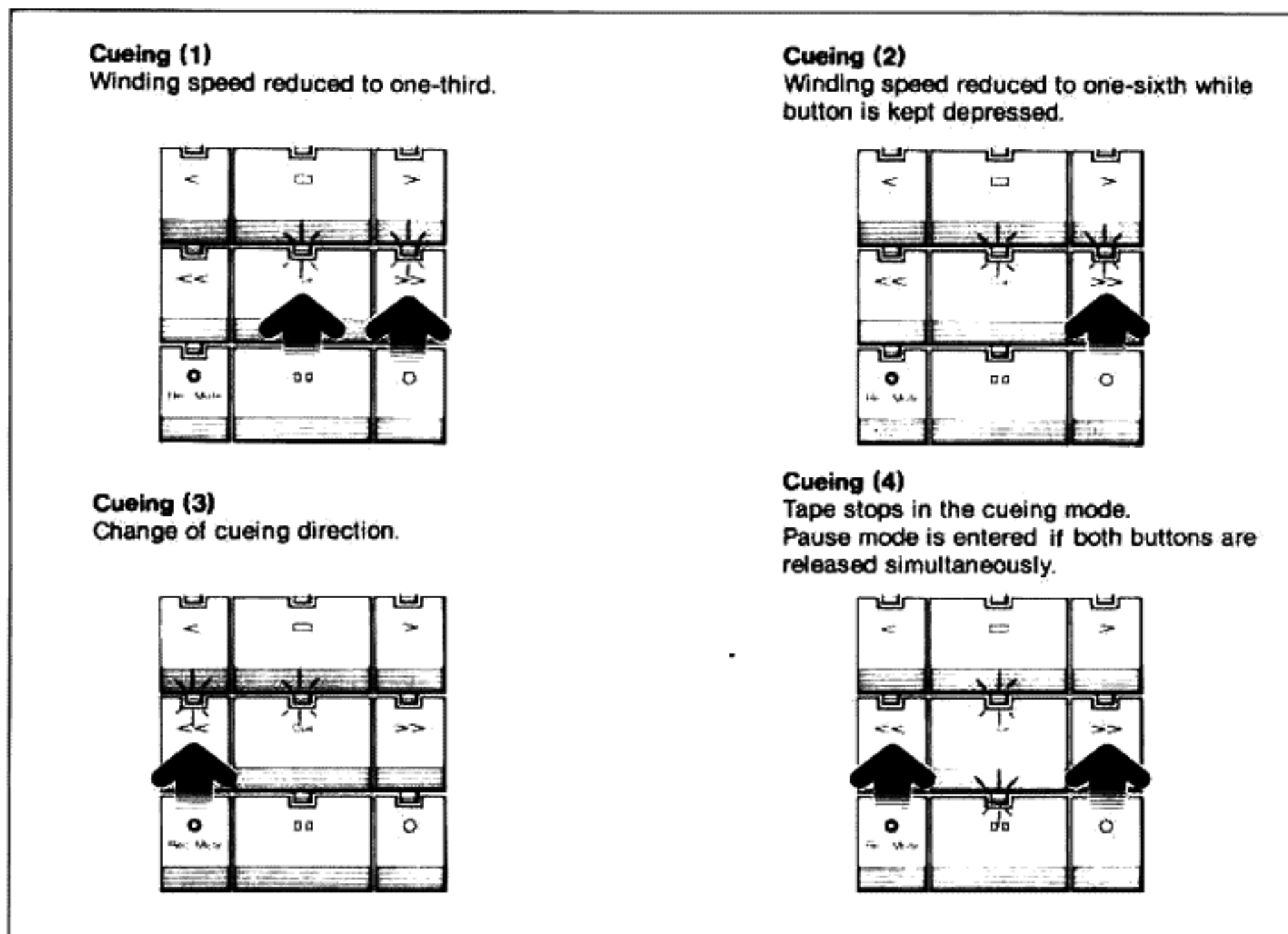
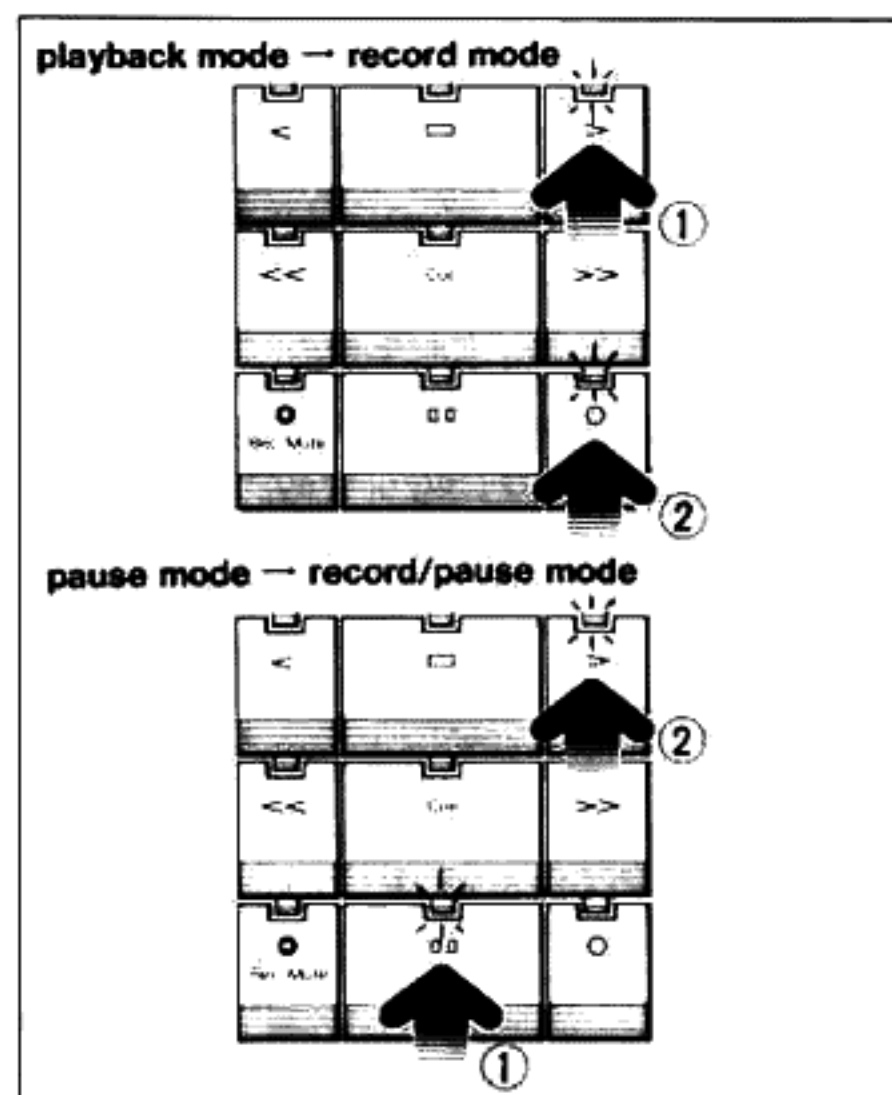

#### 6. Timer Recording or Playback

This deck incorporates a self-start feature which enables you to make unattended recordings or start playback at a pre-selected time with the use of a timer. Recording is possible in the forward direction only, and playback can be set to forward direction only or auto-reverse playback, starting with the forward direction.

##### ■ Operation



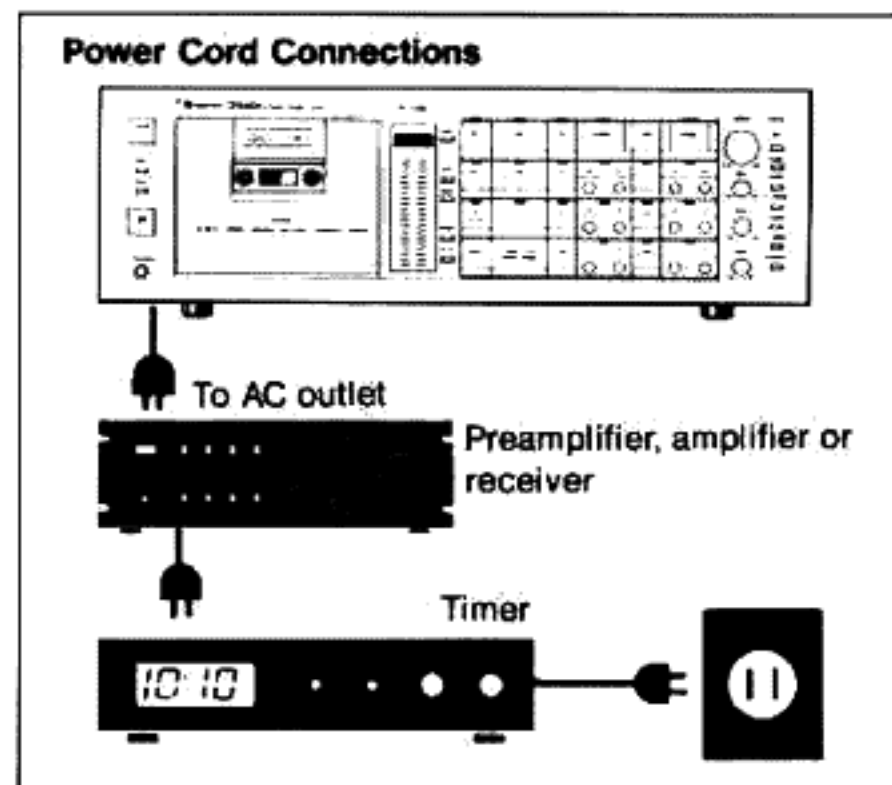



- (1) Make connections as shown in the chart.





# Playback

- (2) Insert the tape for recording or playback and turn on the power to all components.
- (3) For timer recording, set the recording level to suit the expected input signal. For timer playback, set the output control to the desired level and confirm that the auto reverse switches are set to the desired position. Check if all components are set up properly.
- (4) Set the timer switches as follows:

	 Timer On/Off	 Auto Reverse
for timer playback		
for timer recording		

- (5) Adjust the timer to the desired starting time.
- (6) At the pre-selected time, the timer will supply power to the components, and the deck will start recording or playing.
  - When the timer recording or playback feature is not to be used, be sure to set the timer on/off switch (upper switch) to the "Off" position.

## 7. Subsonic Filter and MPX Filter

### (1) Subsonic Filter

If subsonic noise produced by turntable rumble, tonearm resonances etc. when playing phonograph records is recorded on the tape deck, the playback signal may become modulated, which will be heard as sound fluctuations similar to flutter effects. The subsonic filter serves to cut off these harmful noise elements in the subsonic frequency range. If necessary, set the subsonic filter switch to "On" when recording from phonograph records.

### (2) MPX Filter

The 19-kHz multiplex carrier signal can cause erroneous operation of the Dolby NR circuits when recording from FM broadcasts. The MPX filter serves to cut off any remains of this carrier signal. Setting the MPX filter switch to "On" activates the filter. When recording from other program sources except FM broadcasts, the switch should be set to "Off".

## The Playback Auto-Reverse System

This cassette deck incorporates a playback auto-reverse system which permits automatic playback direction reversal from side A to side B or vice versa, simply by setting the auto reverse switches to the desired position. The need to remove the cassette and turn it over at the end of one side is completely eliminated. Automatic playback of side B after side A, and also endless playback of both sides is possible. The unique reverse system of this cassette deck operates as follows: If during playback of

side A (B), a blank section (recorded level below -30 dB) of more than 20 seconds is detected, the tape is automatically fast-forwarded to the end of the side, there directions are reversed and the tape is again fast-forwarded for the presumed interval of the leader tape section. Playback then starts at the beginning of the magnetic tape section of side B (A).

- If a low-level recorded section of less than -30 dB continues for more than 20 seconds, the reverse operation will be triggered even during playback of a musical selection.

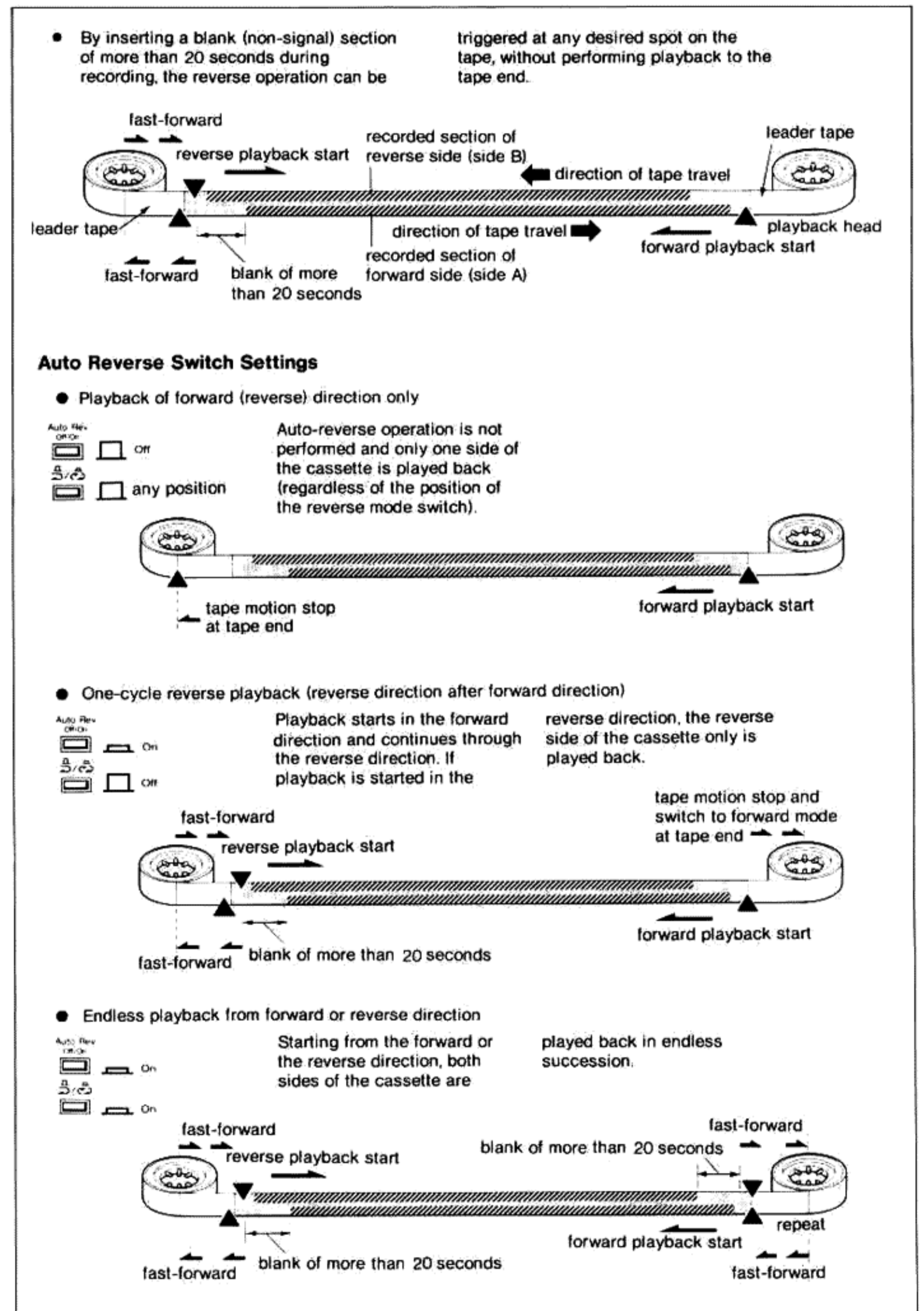



## NAAC (Nakamichi Auto Azimuth Correction) System

In order to ensure perfect performance of the auto-reverse feature, this deck incorporates a revolutionary system called NAAC for automatic correction of the playback head azimuth. When playing back a tape, slight differences in tape travel characteristics between sides A and B would lead to azimuth losses (due to misalignment of the head vs. the tape). The NAAC system automatically corrects azimuth misalignment and maintains proper playback head azimuth at all times. Thereby the difference in sound quality between playback of side A and side B, which tended to be a problem in auto-reverse systems, has been completely eliminated.

Playback head azimuth is constantly controlled in the forward and reverse playback modes as well as in the forward recording mode. When automatic correction is being performed, the respective direction indicator flashes as a visual indication.

- The NAAC system operates with musical signals above 3 kHz recorded on the tape. If a tape with music containing only little energy in this range is used, the direction indicator may sometimes flash and the adjustment will require more time.
- After a cassette tape was ejected or after reversal of playback direction, the playback head is set to the standard azimuth position (ordinary azimuth angle). If a tape with little azimuth misalignment is used in this condition, the NAAC system may not be activated.

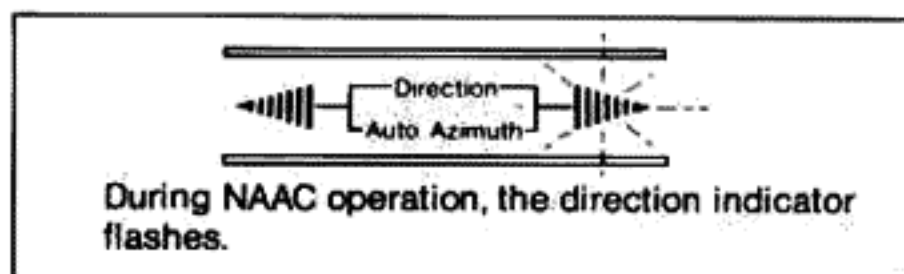

### Playback Operation

- (1) Confirm that the timer switch is set to "Off", then turn on the power to the deck by depressing the power switch.
- (2) Open the cassette holder by depressing the eject button.
- (3) Insert the cassette into the holder. Push the cassette holder back until it locks into the panel.
- (4) Set the monitor switch to "Tape".
- (5) Set the Eq switch to 120  $\mu$ s or 70  $\mu$ s, according to the tape used. (—p.12)
- (6) For playback of a tape which was recorded with the Dolby NR system, set the Dolby NR on/off switch to "On" and select the required system with the B-Type/C-Type switch.  
For playback of a tape which was recorded without the Dolby NR system, set the Dolby NR on/off switch to "Off".

	Dolby NR On/Off	B-Type/C-Type
Playback with Dolby B-Type NR		
Playback with Dolby C-Type NR		
Playback without Dolby NR		any position

- (7) Select the desired auto-reverse operation with the auto reverse switches. (Refer to "The Playback Auto-Reverse System".)
- (8) To start playback from side A of the tape, press the forward play button. To start playback from side B, press the reverse play button.
- (9) Adjust the output level control to the desired level.

## Before Recording

**Be sure to read this paragraph and perform the respective adjustments before starting to record.**

There are many brands of cassette tapes, which can be generally classified into three types: chrome-equivalent tapes, normal tapes (ferric-oxide formulations) and metal tapes. Tapes from the list on page 12 can be used with this deck simply by setting the tape selector buttons and the Eq switch to the appropriate positions. However, even with tapes of the same general type, there are certain individual differences. In order to perfectly match the deck to the tape and extract full performance, this deck provides manual adjustment facilities for record sensitivity (record/play level) and bias current. The manual adjustment process is aided by a microprocessor, which makes for swift and simple operation.

### Order and Procedure of Calibration

#### 1. Order of Calibration

The manual calibration is to be performed in the following order:

##### (1) Record/Play Level Calibration



##### (2) Bias Calibration

For the bias calibration, correct playback head azimuth is of great importance. Therefore, if an azimuth correction is required, the NAAC system automatically goes into operation

- (10) For short-term interruption of playback, press the pause button. To resume playback, press the respective play button again.

- With this deck, you can change from any transport mode into any other, i.e. from forward playback to reverse playback, from forward or reverse playback to fast-forward, etc. without having to use the stop button.
- While the tape is in motion or in the pause mode, the eject button is inoperative and the cassette holder does not open even if the button is pressed. While the cassette holder is open, all tape control buttons are inoperative.
- During playback, this deck's peak level meters display the level recorded on the tape. Readings are not affected by turning the output level control.

immediately after the bias calibration button is pushed. During the adjustment process of the playback head azimuth, the direction indicator flashes. Start the bias calibration only after the indicator has stopped flashing and is lit constantly. If no azimuth correction is required, the direction indicator is lit constantly from the beginning.

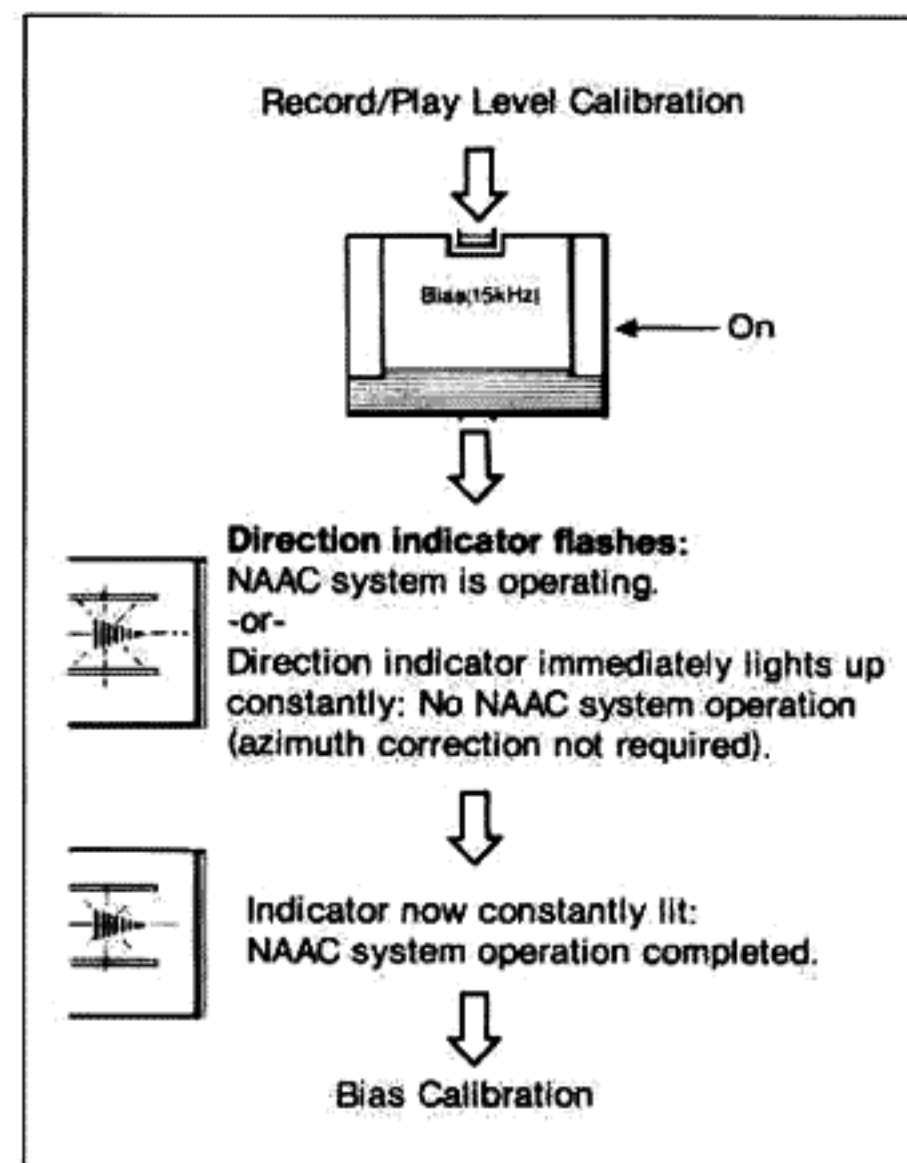



## Manual Calibration Procedure

- (1) Confirm that the timer switch is set to "Off", then turn on the power to the deck by depressing the power switch.
- (2) Insert the cassette to be used for recording.
- (3) Set the Dolby NR switch to "Off" and select the appropriate positions of the tape selector buttons and the Eq switch for the tape in use.
- (4) While keeping the record button depressed, push the pause button to put the deck into the record stand-by (record/pause) mode.
- (5) Set the monitor switch to "Tape".
- (6) Press the level calibration button. The indicator above the button lights up and the deck automatically goes from record stand-by into the record mode. Simultaneously, the tape counter is automatically reset to "0000".

After the tape motion has started, the indicator of the sensitivity controls corresponding to the selected tape position lights up, and the peak level meters display the record/playback level of the 400 Hz (0 dB) test tone.

- (7) If the meter indication is higher than the "Cal." point on the outer scale of the peak level meters, turn the corresponding sensitivity control counterclockwise, and if meter indication is lower, turn it clockwise until the meter reading is at the "Cal." marking for both left and right channels.
- (8) Next, bias calibration is to be performed. After completion of level calibration as described in the preceding paragraph, but with the tape still running in the record mode, press the bias calibration button. The indicator above the button and the indicator

### 1. Level Calibration

This calibration corrects different levels in recording and playback which are due to sensitivity differences of various tapes. If level differences remain uncorrected, they can cause malfunction of the noise reduction system and degrade sound quality. Therefore this calibration should be performed when changing to a cassette of another brand even if it is to be used at the same tape selector position (for example changing from the normal-position Nakamichi EX to EX II, etc.). If exactly the same brand of cassette is used continuously, repeated calibration is not imperative, but a quick check is recommended. The calibration is performed using the built-in test tone of 400 Hz (0 dB).

of the bias controls corresponding to the selected tape position light up. The peak level meters display the record/play level of the 15 kHz (-20 dB) test tone with increased sensitivity.

- If correction of playback head azimuth by the NAAC system is being performed, the direction indicator flashes. Confirm that the indicator has stopped flashing and is constantly lit before proceeding to the next step. If no azimuth correction is required, the NAAC system does not operate and the direction indicator is lit constantly from the beginning.

### 2. Bias Calibration

Bias is an inaudible high-frequency current used in the recording process. When bias is increased, distortion decreases but high-frequency response declines. On the opposite, when bias is decreased, distortion rises but high-frequency response improves. By means of the tape selector buttons, the appropriate bias range for normal, chrome-equivalent or metal tapes is chosen, and the bias controls permit fine adjustment. As the bias requirements differ for various brands of cassettes and even tapes of the same brand may have slightly different bias requirements, a bias check and adjustment should be performed every time a new cassette is used for recording. The calibration is performed using the built-in test tone of 15 kHz (-20 dB).

- (9) If the meter indication is higher than the "Cal." point on the outer scale of the peak level meters, turn the corresponding bias control counterclockwise, and if meter indication is lower, turn it clockwise until the meter reading is at the "Cal." marking for both left and right channels.
- (10) Press the calibration reset button to terminate the calibration process. The record mode is released, the tape stops and then is automatically rewound to the starting point of calibration (tape counter indication "0000"). The manual calibration procedure is now completed.

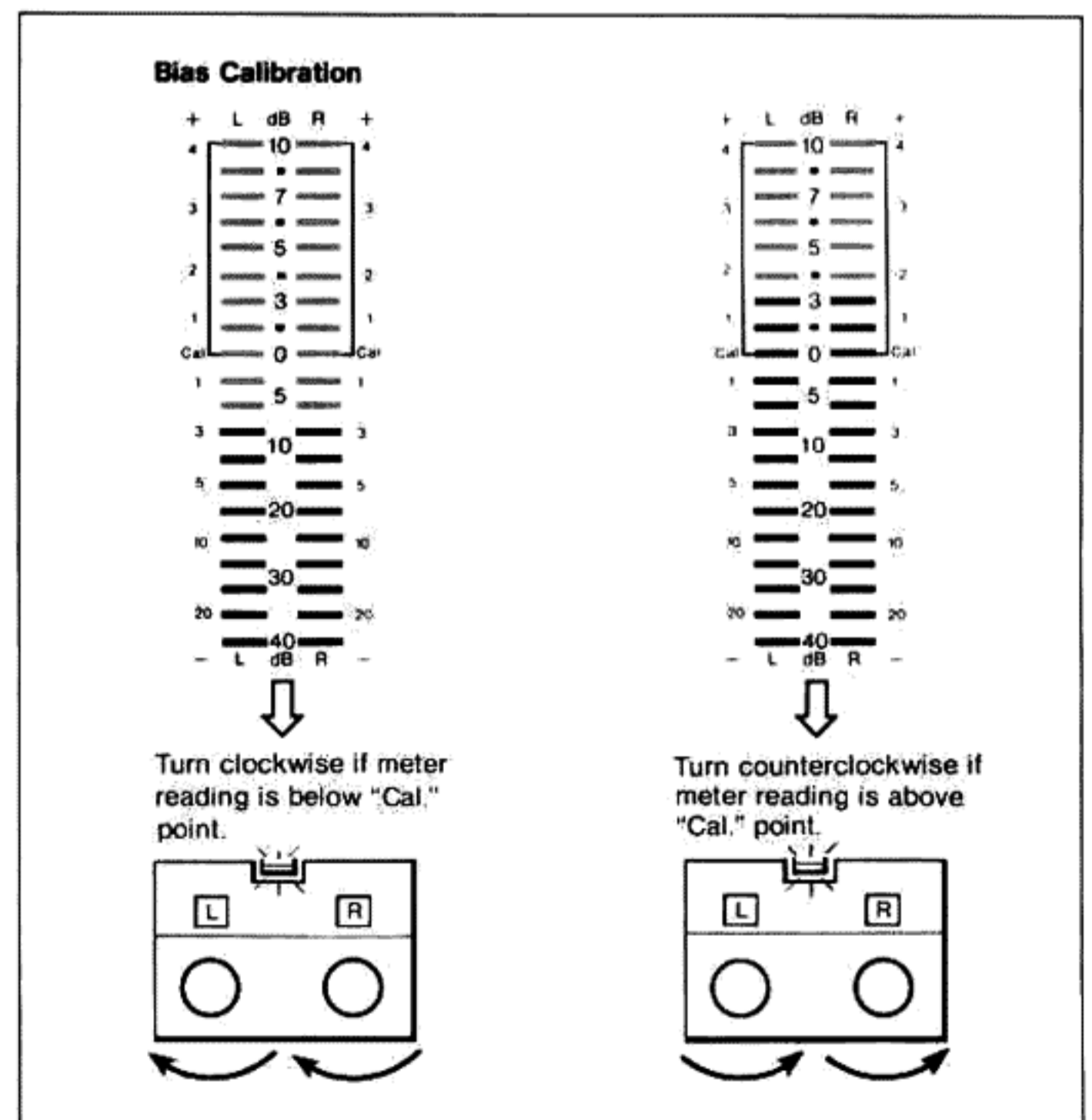
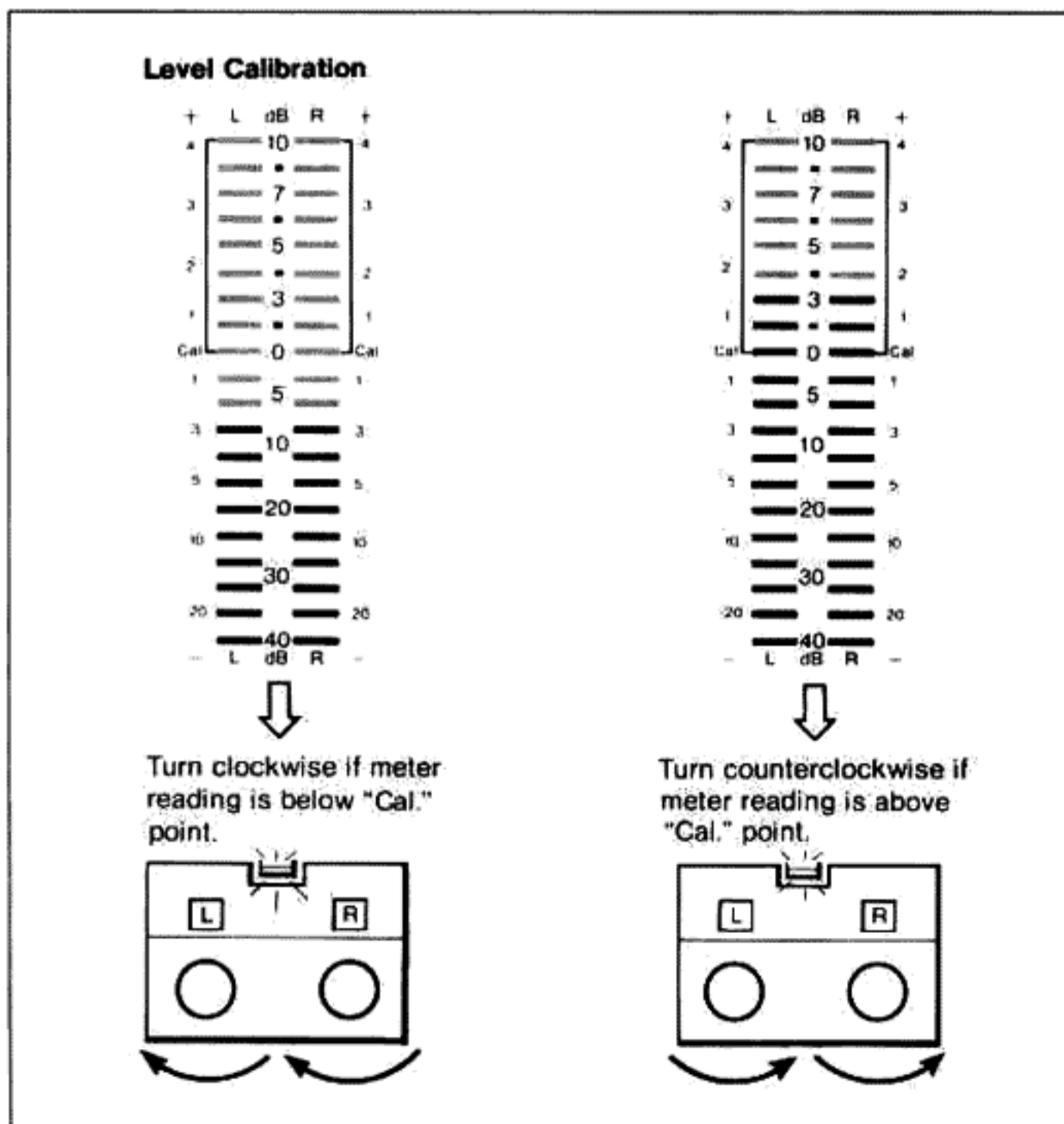



## ■ Ordinary Calibration Cannot Be Performed

If for some reason the settings of the bias and sensitivity controls were greatly disturbed, correct bias adjustment may not be possible. This is due to the fact that the recorded test tone level is too low, which prevents the NAAC system from properly adjusting the azimuth. In such a case, first perform a rough adjustment of level and bias before proceeding to the ordinary manual calibration.

## ■ Rough Adjustment

- (1) Confirm that the correct tape selector button for the tape in use is pushed.
- (2) Turn the bias controls corresponding to the selected tape position fully counterclockwise (maximum bias).
- (3) Turn the sensitivity controls corresponding to the selected tape position fully clockwise.
- (4) Press the level calibration button and adjust the sensitivity controls for a peak level meter reading of  $-1$  to  $0$  dB for both channels.
- (5) Press the bias calibration button. If the NAAC system is operating, wait until the direction indicator has stopped flashing and is lit constantly. Then adjust the bias controls so that the peak level meter indication is at the "Cal." point for both channels.

This completes the rough level and bias adjustment. Now perform the regular manual calibration.

## Use of the Test Tone

The built-in test tone can be used not only for record/playback level and bias calibration, but also for level calibration with other audio components, etc.

## ■ Operation

- Turn the output level control to maximum and set the monitor switch to "Source".
- For use of the 400 Hz (0 dB) test tone, press the level calibration button. For use of the 15 kHz ( $-20$  dB) test tone, press the level calibration button and then the bias calibration button. The respective test tone is now fed out from the output jacks and is also displayed on the deck's peak level meters. (The 15 kHz test tone is produced and fed out at  $-20$  dB, but it is displayed on the meters with increased sensitivity.) To switch off the test tone, press the calibration reset button.

## Some Precautions on Calibration

1. Bias calibration and level calibration are performed with the test tone being recorded and the results being displayed on the peak level meters in the "Tape" position of the monitor switch. If the switch is set to "Source" or in other modes (playback), the test tone is not displayed.
2. If a low-quality tape is used, the high-frequency output may not increase even if the bias current is decreased (the bias controls are turned clockwise). Rather, in such a case, distortion only will increase. Therefore it is highly recommended that you use tapes from the list on page 12.
3. During use of the test tone, you should turn down the volume control on your amplifier, because excessive high-frequency levels can cause damage to your speakers.
4. During calibration or use of the test tone, the line input is automatically cut off.
5. Due to temperature influences, the level of the built-in test tone (400 Hz, 15 kHz) may vary slightly at times. To perform very exact bias and level calibration, set the monitor switch to "Source" while the test tone is being displayed and check the actual indication. Then return the monitor switch to "Tape" and perform calibration in such a way that the meter readings in the "Tape" position are the same as in the "Source" position.

## ■ Manual Calibration Flow Chart

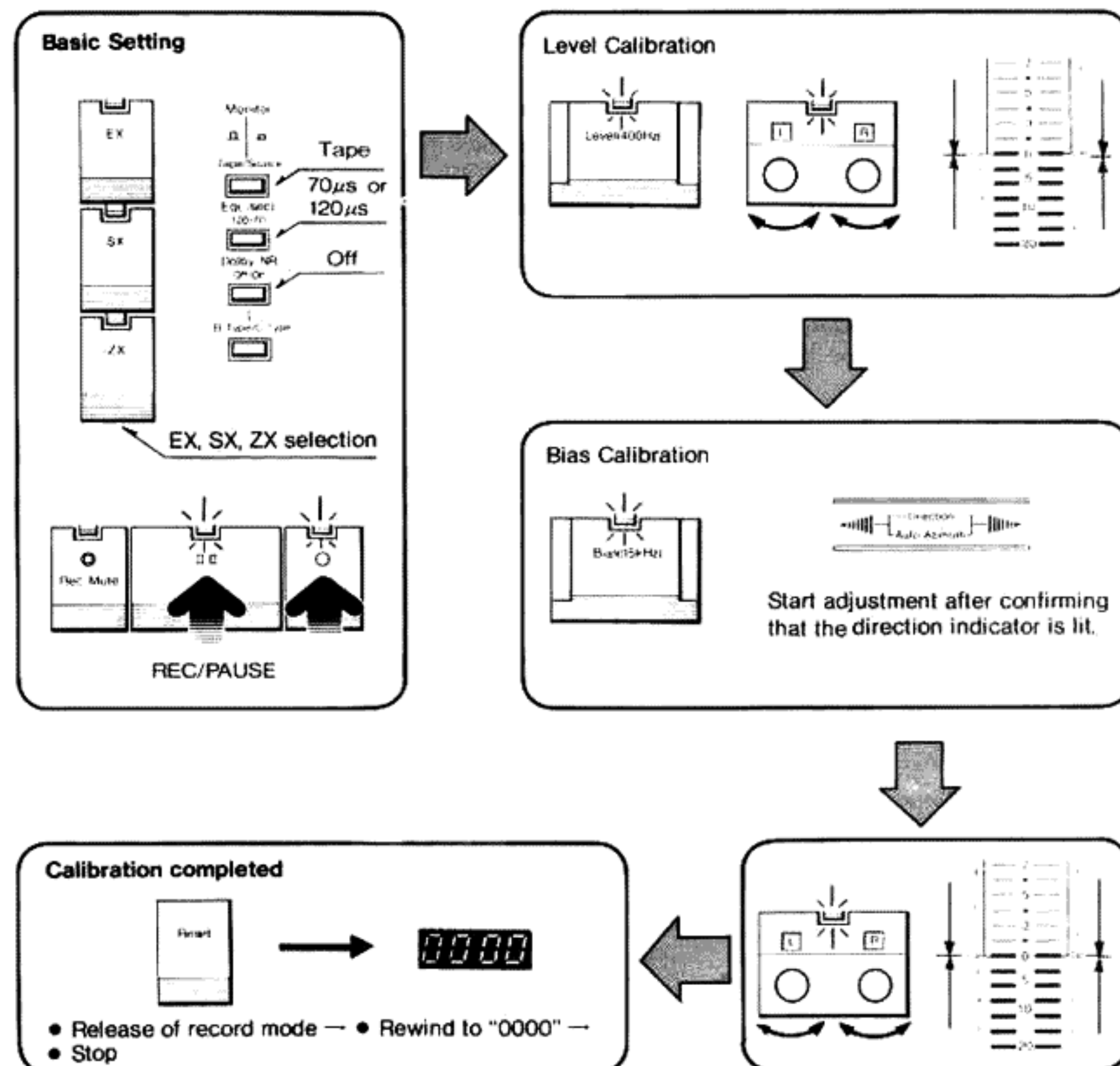

# Recording

This deck permits forward and reverse playback, but recording can only be carried out in the forward direction.

- (1) Confirm that the timer switch is set to "Off", then turn on the power to the deck by depressing the power switch.
- (2) Open the cassette holder by depressing the eject button.
- (3) Insert the cassette into the holder with the side you want to record facing outwards. Push the cassette holder back until it locks into the panel.
- (4) Select the required positions of the tape selector buttons and the Eq switch for the tape in use. (See chart)
- (5) Has record/play level calibration and bias calibration been performed for the tape in use? If not, refer to the paragraph "Before Recording" on page 9, and perform manual calibration.
- (6) If the Dolby NR system is to be used for recording, set the Dolby NR on/off switch to "On" and select the desired system with the B-Type/C-Type switch. If the Dolby NR system is not to be used, set the on/off switch to "Off".

	Dolby NR ON/OFF	B-Type/C-Type
Playback with Dolby B-Type NR		
Playback with Dolby C-Type NR		
Playback without Dolby NR		any position

- (7) When recording from FM broadcasts, set the MPX filter switch to "On". When recording from phonograph records, set the subsonic filter switch to "On", if required.
- (8) Press the tape counter reset button to return the counter indication to "0000". When the memory on/off switch is set to "On" and the stop/play switch to "Stop", the tape will stop at the "0000" point in rewind. If the stop/play switch is set to "Play", playback starts automatically at the "0000" point.
- (9) Set the monitor switch to "Source" and adjust the record level. First turn up the master input level control to a certain degree. Then, while watching the indication of the peak level meters, gradually turn up the left and right input level controls to achieve the proper recording level and left/right channel balance. For final adjustments of the overall recording level, the master input level control can again be used. (→p.13)

## Tape Selector Button and Eq Switch Settings (Recommended Tapes)

### EX/120 μs Position

Tape Selector Buttons, Eq Switch	Brand Name
	<b>Nakamichi</b> EX, EXII <b>TDK</b> AD, AD-X <b>Maxell</b> UD, UD-XLI, XL-IS <b>Fuji</b> FR-I <b>AMPEX</b> GM-I

### SX/70 μs Position

Tape Selector Buttons, Eq Switch	Brand Name
	<b>Nakamichi</b> SX, SXII <b>TDK</b> SA-X <b>Maxell</b> UD-XLII, XL-IIS <b>Fuji</b> FR-II <b>AMPEX</b> GM-II

### ZX/70 μs Position

Tape Selector Buttons, Eq Switch	Brand Name
	<b>Nakamichi</b> ZX <b>TDK</b> MA, MA-R <b>Maxell</b> MX <b>Fuji</b> FR-Metal <b>AMPEX</b> MPT

- This deck is not suited for use with ferri-chrome cassettes.

- Press the tape selector buttons firmly and make sure that the appropriate indicator is lit.

- (10) While keeping the record button depressed, push the pause button to put the deck into the record stand-by (record/pause) mode. The orange record button indicator and the green pause button indicator light up.
  - ★ If you want to start the recording with a fade-in, press the "Down" button of the auto fader to set the fader to minimum.
- (11) Press the forward play button to start recording.
  - ★ To perform fade-in, now press the "Up" button of the auto fader. The recording level is automatically raised to the level determined in step (9).
- (12) To check the quality of the recording in progress, you can instantly monitor the playback signal by setting the monitor switch to "Tape". In the "Source" position, the input signal before recording is heard. For short-term interruption of recording, press the pause button. To resume recording, press the forward play button again.

- (13) By pressing the stop button, the recording mode is released and the tape transport comes to a full stop.
  - ★ If you want to end the recording with a fade-out, press the "Down" button of the auto fader to return the fader level to minimum, and then press the stop button. After the stop button was pushed, the auto fader control is automatically released and the level setting returns to the "Up" value.



# Tips on Setting Recording Levels

The LED level meters of this cassette deck are free of "overshoot" problems and display peak levels with a high degree of accuracy. For good recordings, it is essential to maintain a high signal-to-noise ratio. This is achieved by putting as much signal on the tape as is possible without producing distortion. Setting record levels too low will result in noisy recordings, while too high recording levels cause distortion. Finding the proper level between these two extremes is what good recording is all about. The task is facilitated by this deck's level meters which cover a wide 50 dB range and accurately display even very short signal peaks. Refer to the chart as a guideline to set recording levels.

**"Normal" (LH) position tape formulations, "Chrome" position tape formulations:**  
The meters should be allowed to read as high as +5 dB on short program peaks.

**"Metal" position tape formulations:**  
The meters should be allowed to read as high as +8 dB on short program peaks.

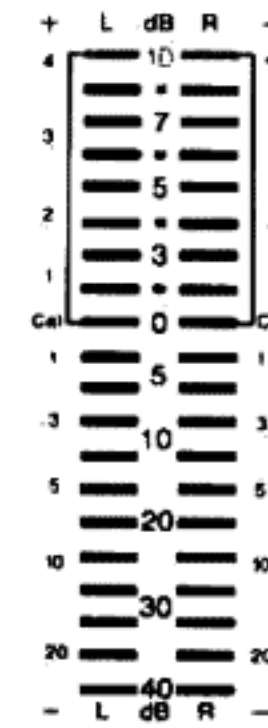
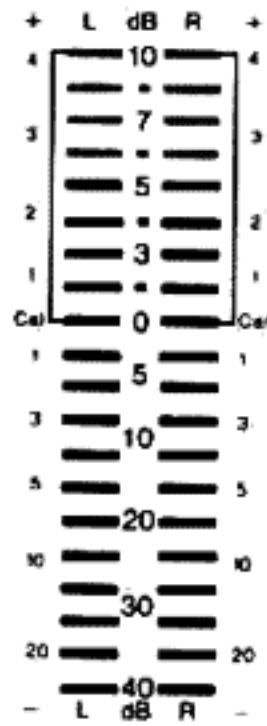

As different tape formulations have slightly different overload (headroom) characteristics, the requirements may vary to a certain degree when using different tapes.

# Dolby Noise Reduction System

This cassette deck provides a choice between the Dolby B-Type NR system and the Dolby C-Type NR system. The Dolby B-Type system reduces noise in the high frequency range by about 10 dB. The Dolby C-Type system achieves a noise reduction of about 20 dB in the range from 2 kHz to 8 kHz, where tape hiss etc. is most objectionable to human hearing. For playback of tapes from your collection which were recorded with Dolby B-Type noise reduction, set the B-Type/C-Type selector to "B-Type". For playback of tapes recorded with Dolby C-Type noise reduction, set the selector to "C-Type".

- The Dolby NR system does not reduce any noise already contained in the incoming input signal. You should therefore use recording sources which are as noise-free as possible.

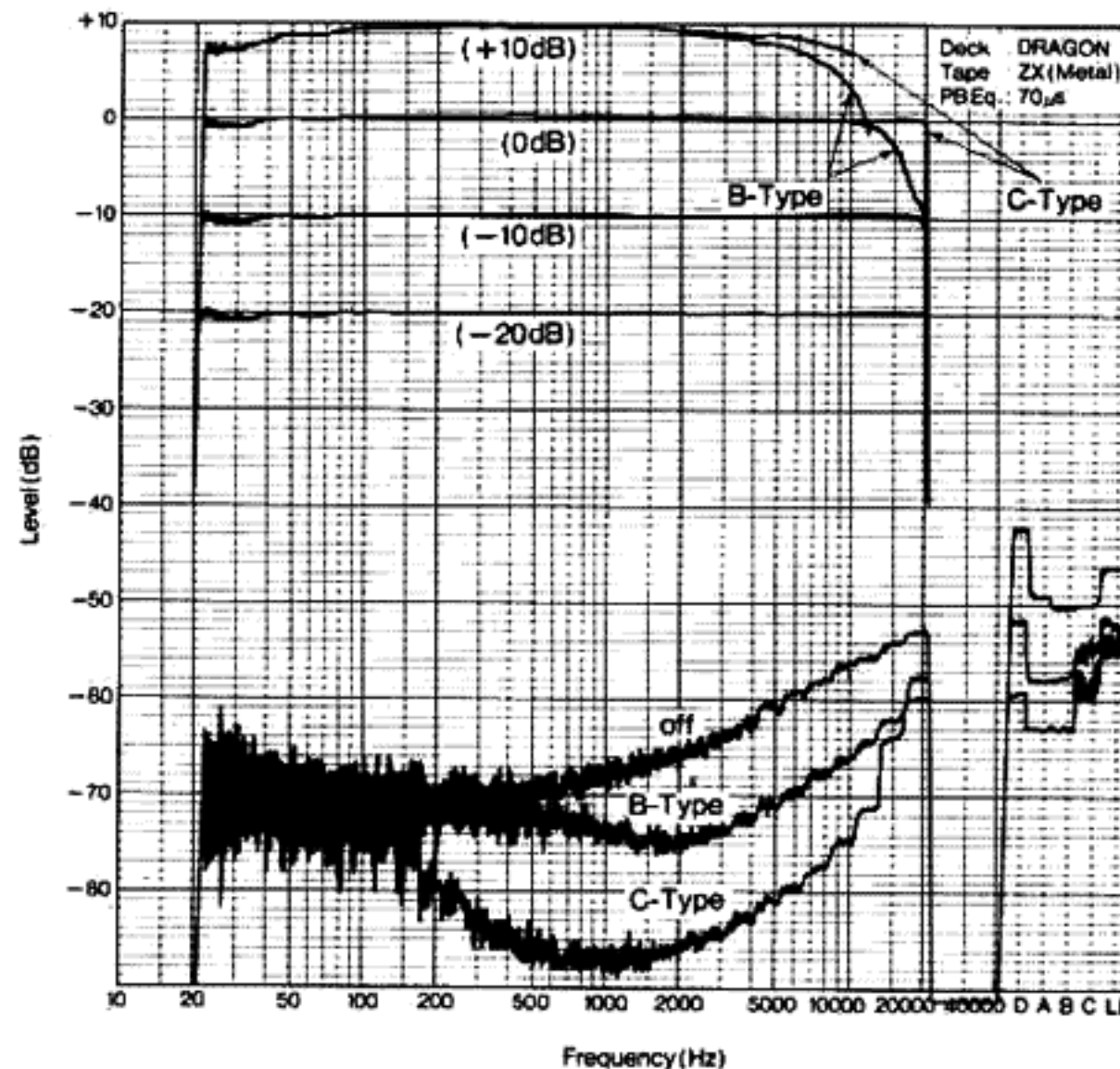

Record/Play Frequency Response and Noise Spectrum Analysis of the DRAGON

# Maintenance

## Head and Transport Cleaning

It is very important to regularly clean the surfaces of the record head, playback head and erase head as well as the capstans, pinchrollers and all other parts which come in contact with the tape. Tiny particles shedded from the tape onto these parts, as well as dust accumulations etc. become the cause of drop-outs, and severely degrade frequency response and wow-and-flutter characteristics. With some low-quality tapes, head contamination is especially severe. Avoid the use of such tapes whenever possible and be sure to keep all parts spotlessly clean.

## Cleaning Procedure

Remove the cover of the cassette holder. Use commercially available cotton-tipped sticks or the like and—with very light pressure—clean the parts indicated in white on the illustration. In case of severe contamination, dip the cotton tip in cleaning fluid. By closing the cassette holder with the cover removed and pressing the pause button, the head assembly can be raised for easy access. To clean the right pinchroller, press the reverse play button. To clean the left pinchroller, press the forward play button. Hold the cotton tip to the revolving pinchroller on the side turning away from the capstan. Be careful that the cotton tip does not get caught between the pinchroller and the capstan. After cleaning the pinchrollers, press the pause button again and clean the capstans.

- Be careful not to apply too much force in cleaning, as the respective parts are critically aligned. Take special care not to damage the tape guides.
- Do not use an excessive amount of cleaning fluid, and give the cleaned surfaces a minute or two to dry off completely before playing a tape.
- If you have used cotton-tipped sticks, be sure not to leave any cotton strands on the cleaned parts.

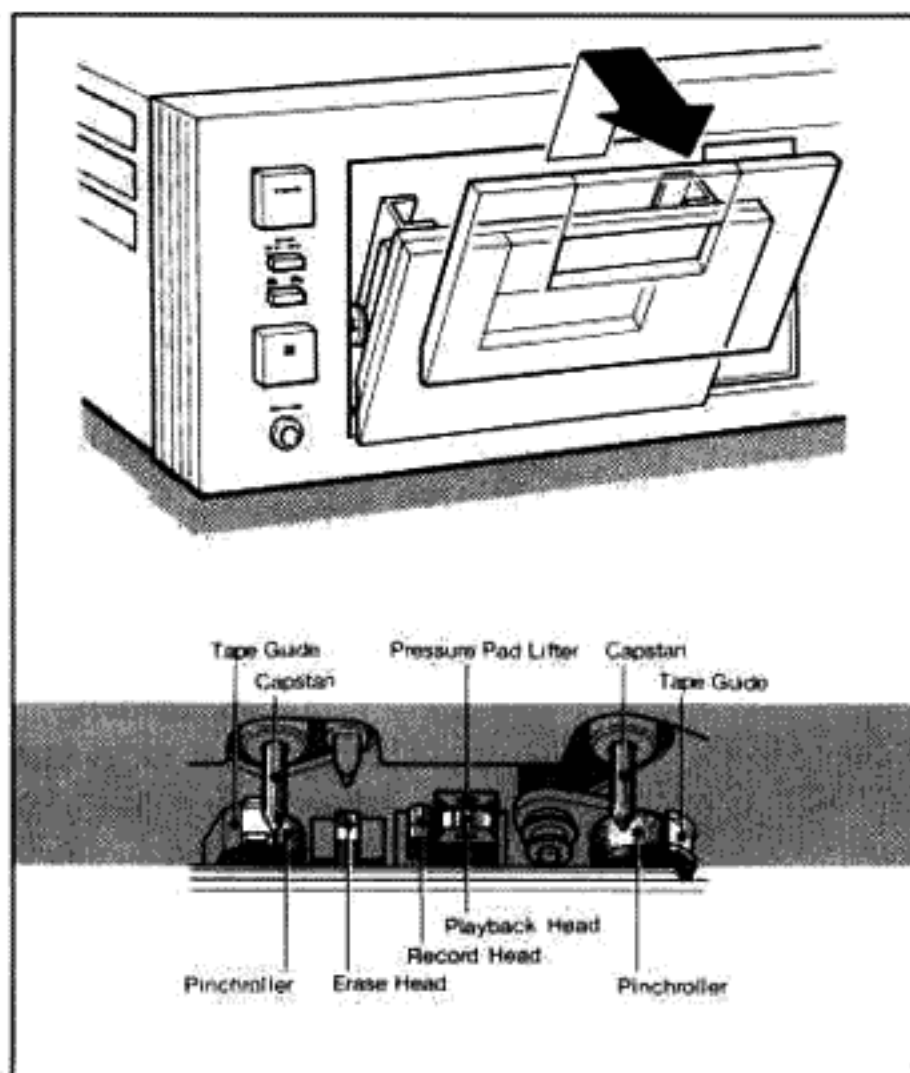

## Demagnetizing

After a longer period of use, there can be a build-up of residual magnetism in the heads and capstans. Such residual magnetism can induce noise and partially erase the high frequencies of a tape being played. To prevent this, you should demagnetize these parts about once every 50 hours of use with the Nakamichi DM-10 Demagnetizer (optional) or any other properly designed demagnetizer.

- Always switch off the power to the deck before starting the demagnetizing procedure.

## Cleaning the Faceplate

Clean the faceplate only by wiping it with a soft, dry cloth. Never use alcohol, solvents, ammonia or abrasive cleaning agents.

## Lubrication

All important moving parts of this deck are fitted with long-life, oil-less bearings. Periodic lubrication is therefore not necessary.



# Troubleshooting

Condition	Probable Cause	Remedy
Tape does not run.	<ol style="list-style-type: none"> <li>1. In order to protect the main drive motor, the power supply to the motor is cut off. (If for example during the cleaning process the revolving capstan is stopped by external force for 10 seconds or more, the protective circuit becomes active and the capstan motor stops.</li> <li>2. Power cord is unplugged.</li> <li>3. Cassette holder not firmly closed.</li> </ol>	<ol style="list-style-type: none"> <li>1. Set the power switch to "off", wait for appr. 30 seconds, and set it to "on" again. While performing head and capstan cleaning, be careful that the cleaning stick etc. does not get caught in the revolving parts.</li> <li>2. Plug in cord firmly.</li> <li>3. Press eject button and then close cassette holder firmly.</li> </ol>
Record mode cannot be entered.	<ol style="list-style-type: none"> <li>4. No cassette inserted.</li> <li>5. Cassette tabs have been removed.</li> </ol>	<ol style="list-style-type: none"> <li>4. Insert the cassette tape.</li> <li>5. Place adhesive tape over tab opening or use new cassette.</li> </ol>
Excessive playback hiss.	<ol style="list-style-type: none"> <li>6. Head is magnetized.</li> </ol>	<ol style="list-style-type: none"> <li>6. Demagnetize head.</li> </ol>
Uneven sound levels, drop-outs, excessive wow/flutter.	<ol style="list-style-type: none"> <li>7. Heads and/or capstans and pressure rollers dirty.</li> <li>8. Faulty cassette.</li> </ol>	<ol style="list-style-type: none"> <li>7. Clean these parts.</li> <li>8. Replace cassette.</li> </ol>
Incomplete erasure.	<ol style="list-style-type: none"> <li>9. Erase head dirty.</li> </ol>	<ol style="list-style-type: none"> <li>9. Clean head and pressure roller.</li> </ol>
Distorted record/playback sound.	<ol style="list-style-type: none"> <li>10. Program material itself is distorted.</li> <li>11. Recording levels are too high.</li> <li>12. Excessive FM carrier leak.</li> <li>13. Wrong tape selector button pushed.</li> </ol>	<ol style="list-style-type: none"> <li>10. Check program material.</li> <li>11. Wide dynamic range permits some short-term overload, but excessive recording levels will cause distortion. Adjust recording levels.</li> <li>12. Set the MPX filter switch to "On" when the Dolby system is used.</li> <li>13. Push the correct button for the tape in use.</li> </ol>
Record mode is entered, but cannot record.	<ol style="list-style-type: none"> <li>14. Input disconnected.</li> <li>15. Head dirty.</li> </ol>	<ol style="list-style-type: none"> <li>14. Check connections.</li> <li>15. Clean head.</li> </ol>
Cannot playback.	<ol style="list-style-type: none"> <li>16. Output disconnected.</li> <li>17. Head dirty.</li> </ol>	<ol style="list-style-type: none"> <li>16. Check connections.</li> <li>17. Clean head.</li> </ol>
Dull high frequencies.	<ol style="list-style-type: none"> <li>18. Heads dirty.</li> <li>19. Tape selector buttons and/or equalizer switch not set correctly.</li> <li>20. Bias amount does not fit tape in use.</li> </ol>	<ol style="list-style-type: none"> <li>18. Clean heads.</li> <li>19. Select correct positions for tape in use.</li> <li>20. Perform bias adjustment.</li> </ol>
Hum heard during recording or playback.	<ol style="list-style-type: none"> <li>21. Strong induction fields near deck.</li> <li>22. Signal cable or connector grounding faulty.</li> </ol>	<ol style="list-style-type: none"> <li>21. Keep deck away from amplifier, transformers, fluorescent lamps, etc.</li> <li>22. Replace signal cables.</li> </ol>

# Specifications

## Specifications

Track Configuration.....	4 tracks/2-channel stereo (playback auto reverse )
Heads.....	3 (erase head x 1, record head x 1, 4-track, 4-channel playback head x 1)
Motors .....	<ul style="list-style-type: none"> <li>• <b>TRANSPORT</b> Quartz PLL DC, brushless, slotless, coreless, Super Linear Torque D.D. motor (capstan drive) x 2 DC motor (reel drive x 1)</li> <li>• <b>AUTO AZIMUTH CORRECTION</b> DC motor x 1</li> <li>• <b>MECHANISM</b> DC motor x 1</li> </ul>
Power Source.....	100, 120, 120/220-240, 220 or 240V AC; 50/60Hz (According to country of sale)
Power Consumption.....	45 W max.
Tape Speed.....	1-7/8 ips. (4.8 cm/sec.)
Wow-and-Flutter.....	Less than 0.019% WTD RMS Less than 0.04% WTD Peak
Frequency Response .....	20 Hz~22,000 Hz $\pm 3$ dB (recording level -20dB, ZX tape) 20 Hz~21,000 Hz $\pm 3$ dB (recording level -20 dB, SX, EX II tape)
Signal-to-Noise Ratio .....	<b>Dolby C-Type NR on</b> < 70 $\mu$ s, ZX tape > Better than 72 dB (400 Hz, 3% THD, IHF A-WTD RMS) <b>Dolby B-Type NR on</b> < 70 $\mu$ s, ZX tape > Better than 66 dB (400 Hz, 3% THD, IHF A-WTD RMS)
Total Harmonic Distortion.....	Less than 0.8% (400 Hz, 0 dB, ZX tape) Less than 1% (400 Hz, 0 dB, SX, EX II tape)
Erasure .....	Better than 60 dB (100 Hz, 0 dB)
Separation .....	Better than 37 dB (1 kHz, 0 dB)
Crosstalk .....	Better than 60 dB (1 kHz, 0 dB)
Bias Frequency.....	105 kHz
Input (Line) .....	50 mV, 50 k $\Omega$
Output (Line).....	1V (400 Hz, 0 dB, output level control at max.) 2.2 k $\Omega$
(Headphones) .....	45 mW (400 Hz, 0 dB, output level control at max.) 8 $\Omega$
BlackBox Series DC Output .....	$\pm 10$ V, 125 mA max.
Dimensions .....	450(W) x 135(H) x 300(D) mm 17-3/4(W) x 5-5/16(H) x 11-13/16(D) inches
Weight .....	Appr. 9.5 kg 21 lb

- Specifications and appearance design are subject to change for further improvement without notice.
- Dolby NR under license from Dolby Laboratories Licensing Corporation.
- The word "DOLBY" and the Double-D-Symbol are trademarks of Dolby Laboratories Licensing Corporation.

## Nakamichi Corporation

Tokyo Office  
Shinjuku Daiichi Seimei Bldg.  
2-7-1 Nishishinjuku, Shinjuku-ku, Tokyo  
Phone : (03) 342-4461  
Telex : 2324721 (NAKAM J)

## Nakamichi U.S.A. Corporation

1101 Colorado Avenue  
Santa Monica, Calif. 90401  
Phone : (213) 451-5901  
Telex : 652429 (NAKREI SNM )

## Optional Accessories

ZX Metalloy Cassette Tape  
C-60, C-90  
SX-II Super Ferricobalt Cassette Tape  
C-60, C-90  
SX Ferricobalt Cassette Tape  
C-60, C-90  
EX II Ferricrystal Cassette Tape  
C-60, C-90  
EX Ferrioxide Cassette Tape  
C-60, C-90

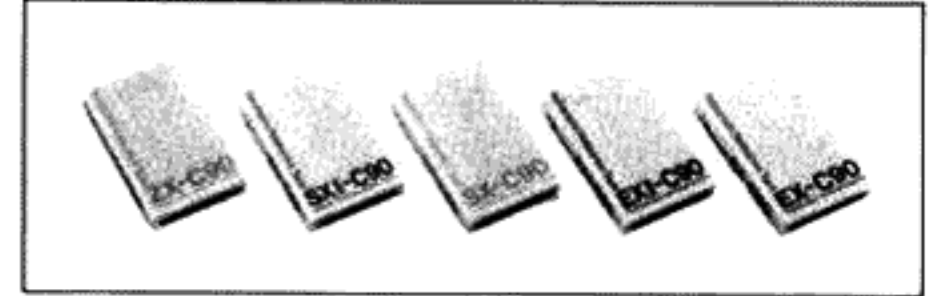

## RM-20 Remote Control Unit



## DM-10 Head Demagnetizer

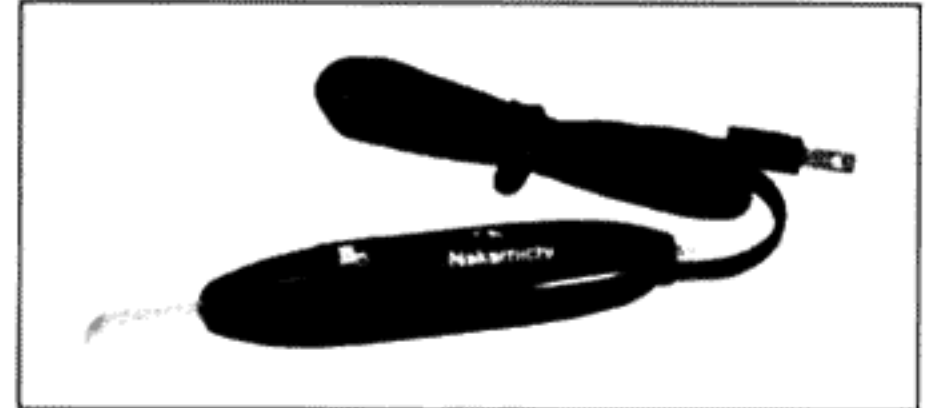

## SP-7 Stereo Headphones



## Nakamichi U.S.A. Corporation

220 Westbury Avenue  
Carle Place, N.Y. 11514  
Phone : (516) 333-5440